

BF-2 200X2,000

縮尺 S=1:10

単位 (mm)

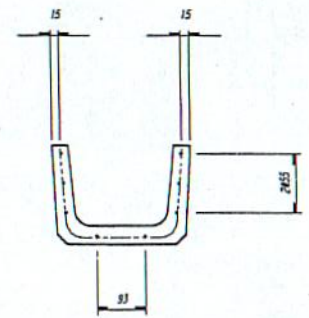
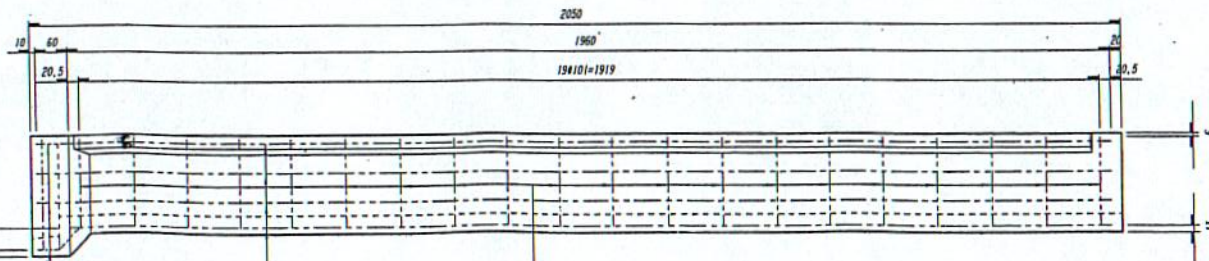
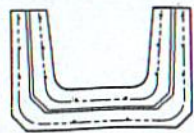
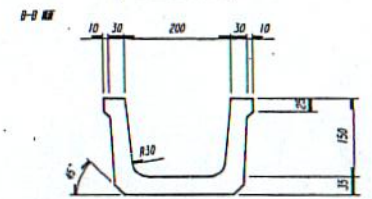
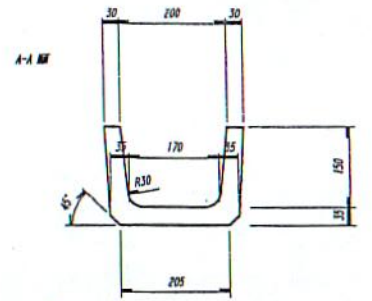
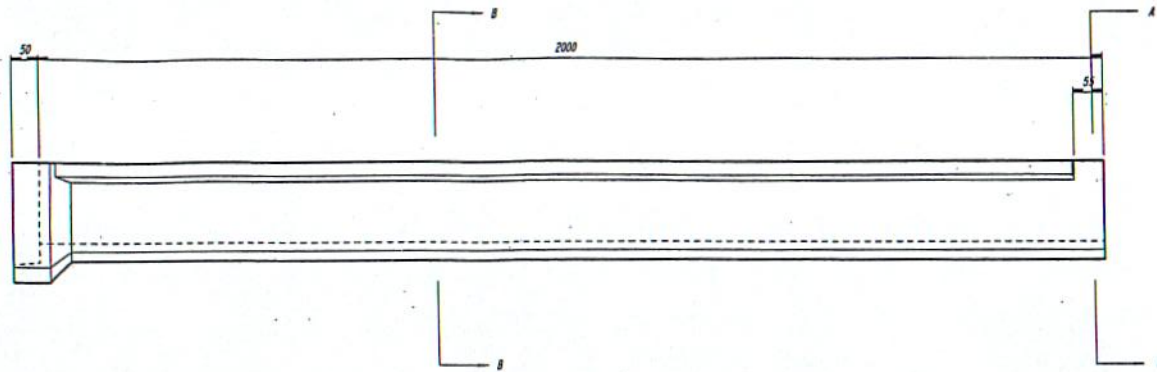
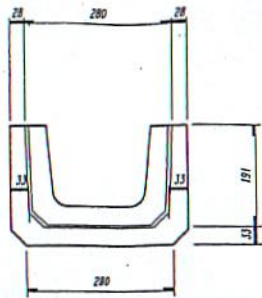

鋼筋 #2, 6-2

鋼筋 #3, 2-4

鋼筋 #3, 2-8

鋼筋 #2, 6-20